











<b>A</b>	8 x	<b>ML</b>	36 x	<b>M1</b>	44 x	<b>SD</b>	4 x	<b>MZ</b>	44 x
									
	8 x 35								
<b>MP</b>	4 x								
									

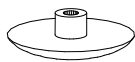

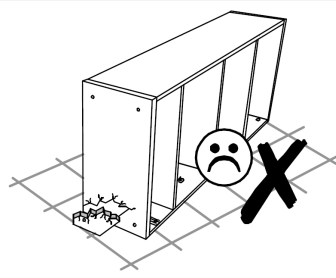
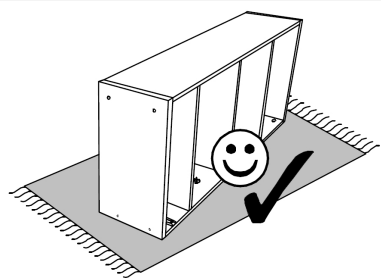
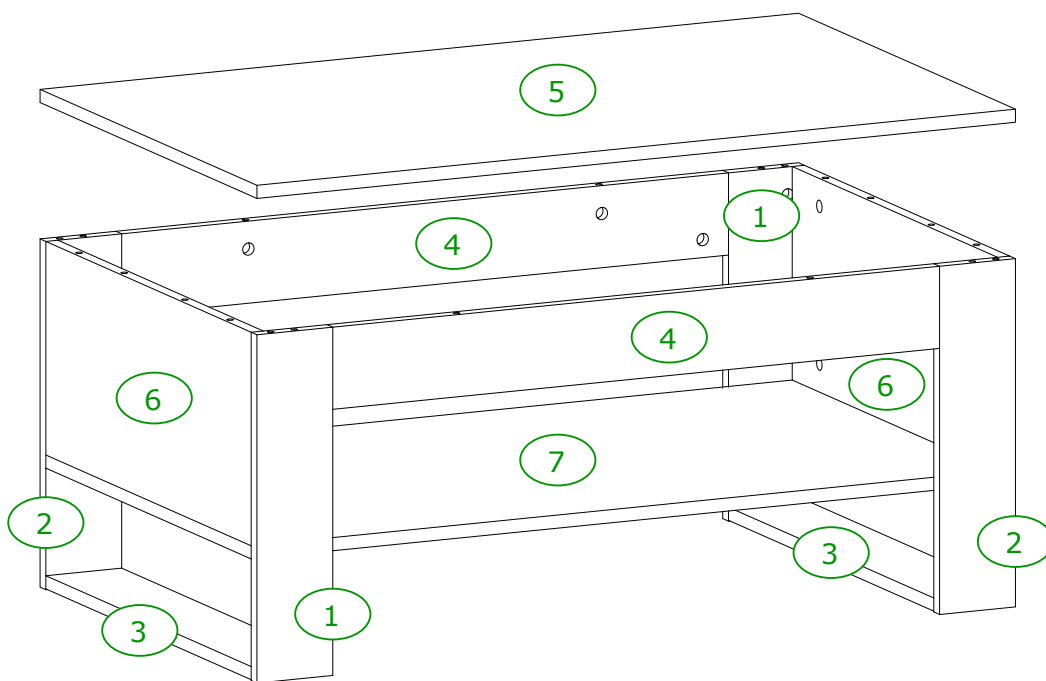
<b>ML</b>	16 x	<b>M1</b>	8 x	<b>SD</b>	4 x	<b>MP</b>	4 x
							

x2

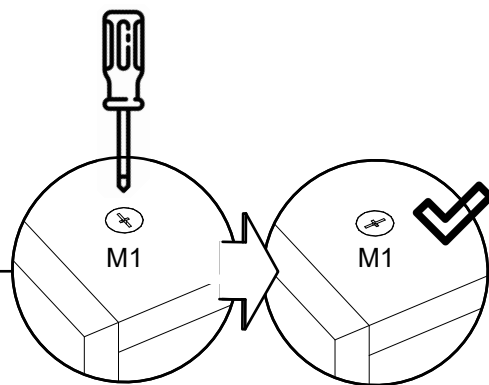
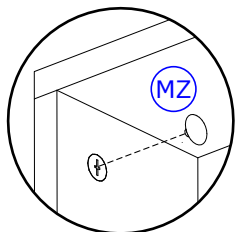
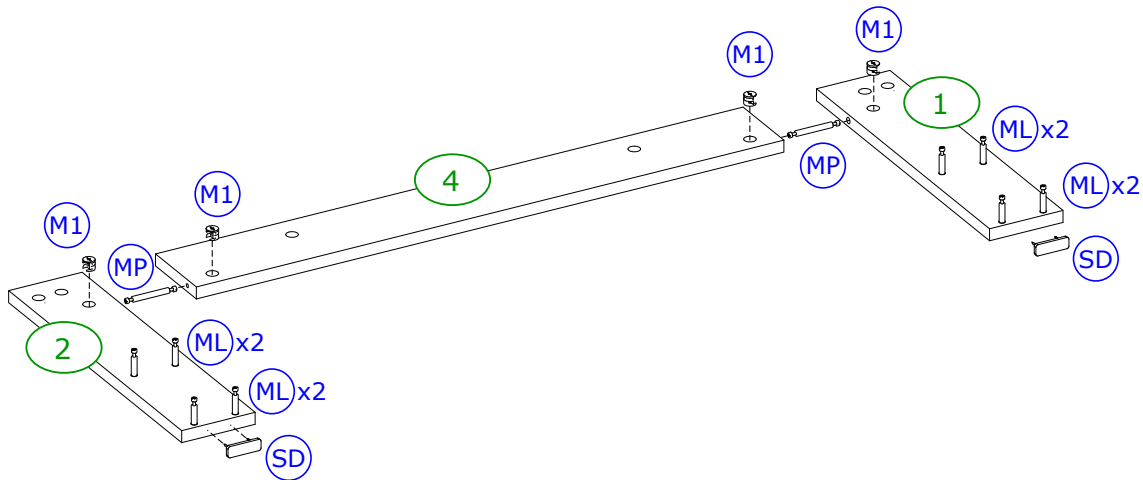

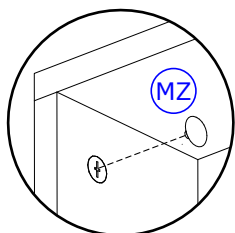
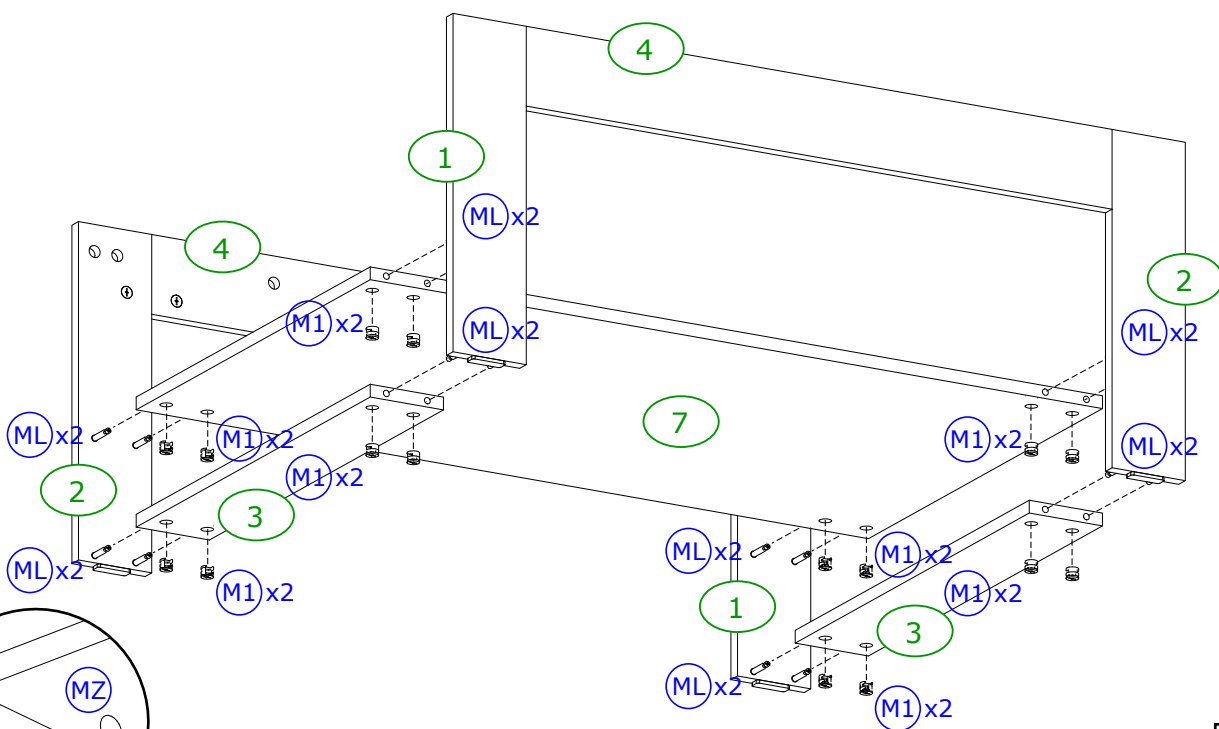

1

<b>M1</b>	16 x
	





2

<b>A</b>	8 x	<b>ML</b>	4 x	<b>M1</b>	4 x
					
	8 x 35				

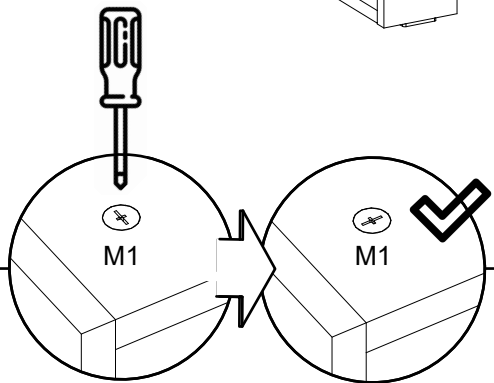
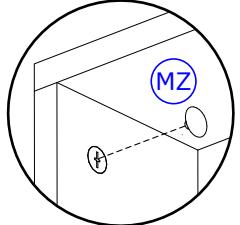
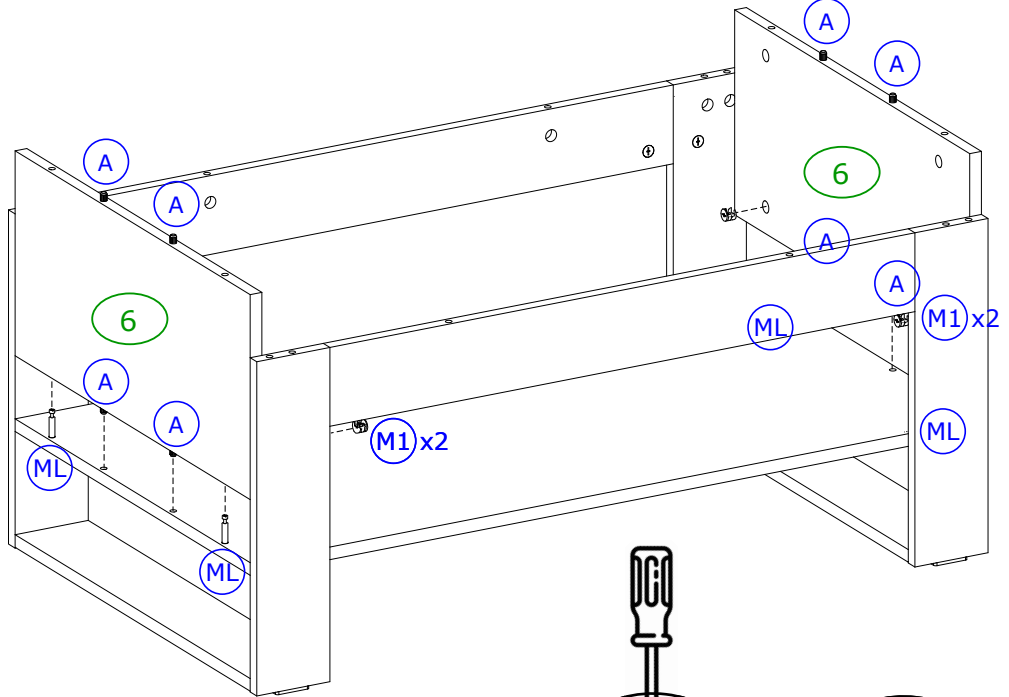
1

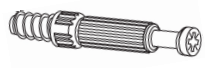

3

<b>ML</b>	16 x	<b>M1</b>	16 x
			

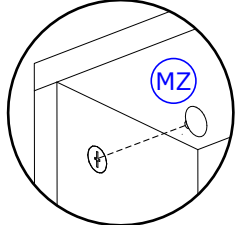
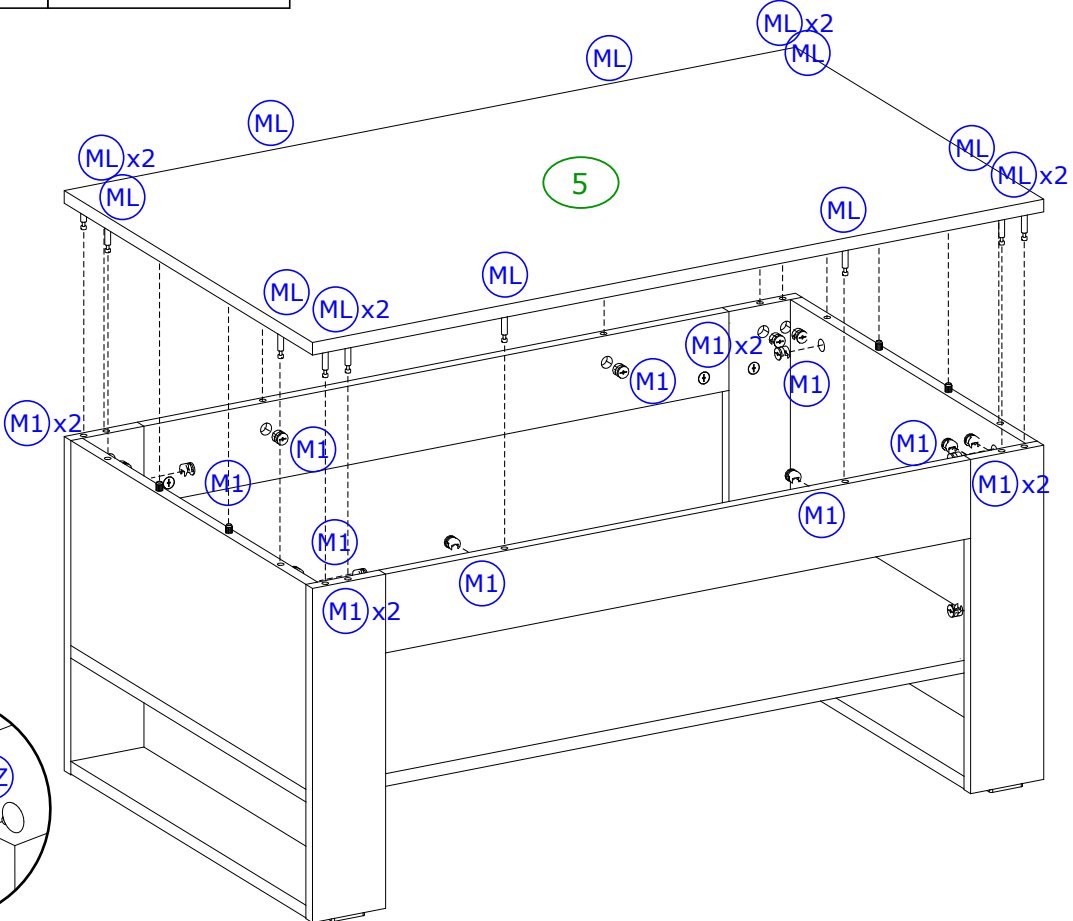

4