

(KC-5)

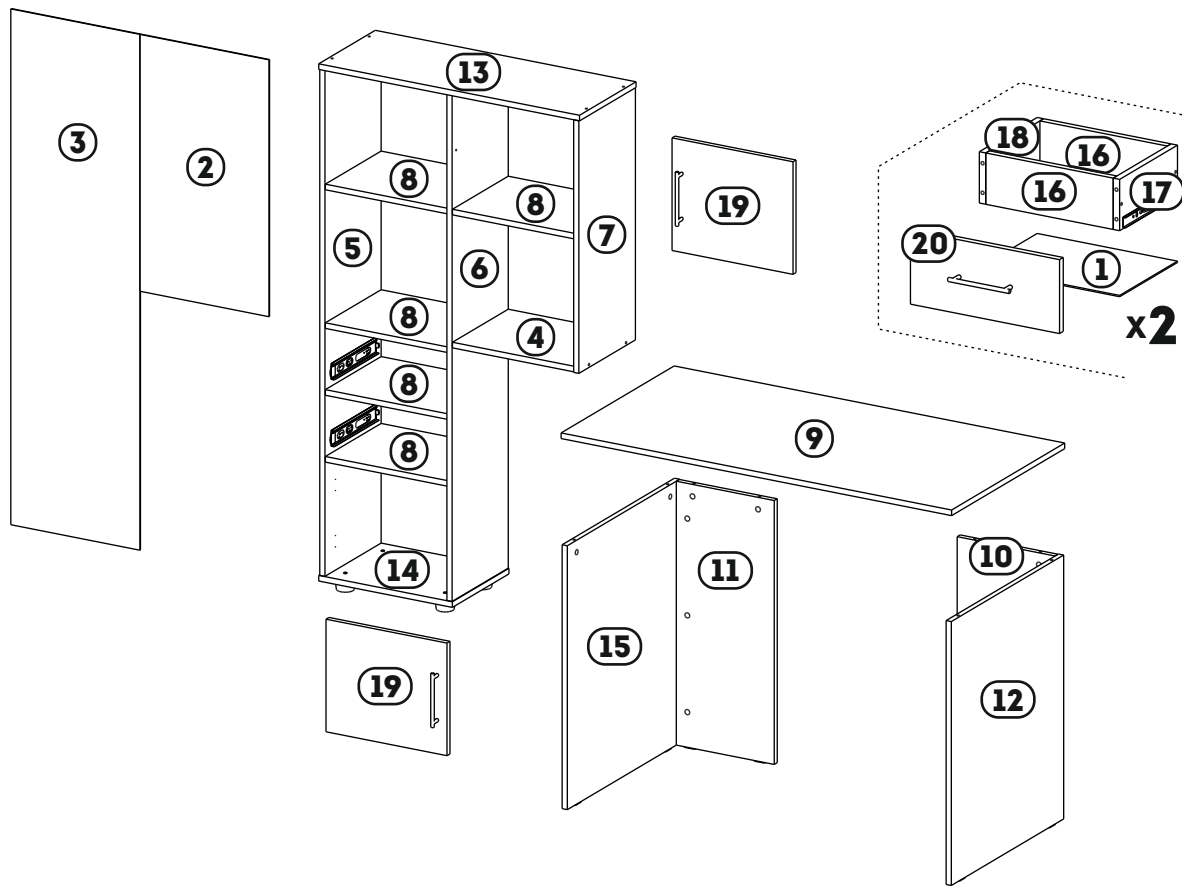

No	a*b	X
1	350x250	2
2	730x398	1
3	1466x398	1
4	376x298	1
5	1438x300	1
6	1438x300	1
7	718x302	1
8	376x298	5
9	1204x604	1
10	750x302	1
11	750x302	1
12	750x600	1
13	804x302	1
14	412x302	1
15	750x600	1
16	318x118	4
17	250x118	2
18	250x118	2
19	320x373	2
20	170x372	2

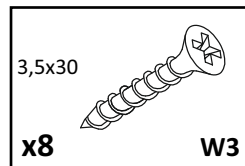

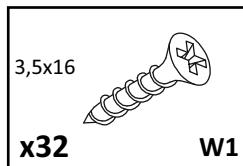
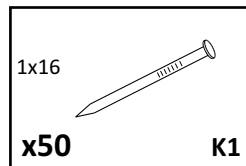
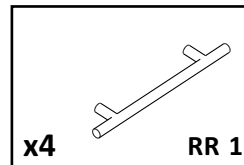
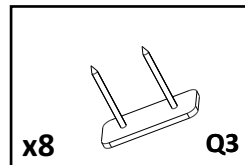
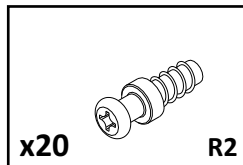
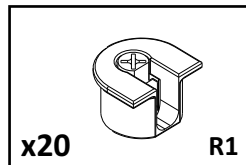
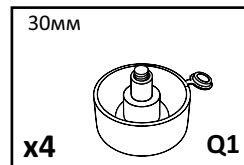
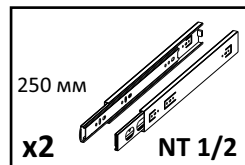
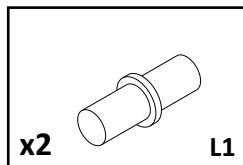
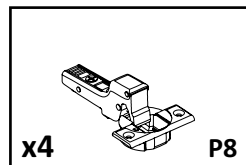
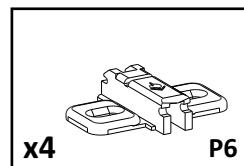
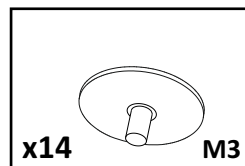
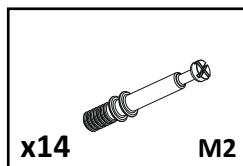
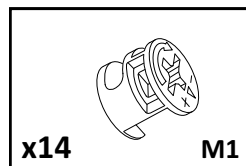
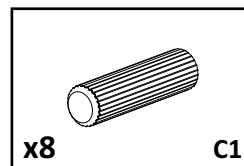
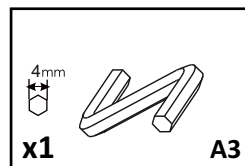
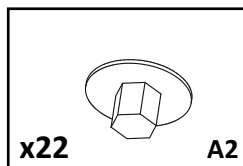
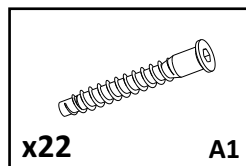
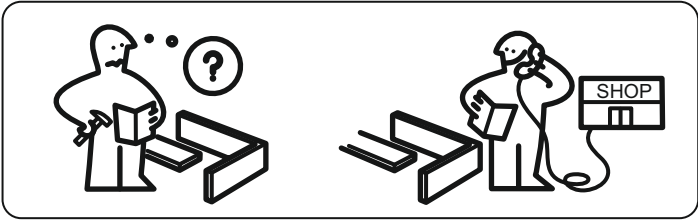
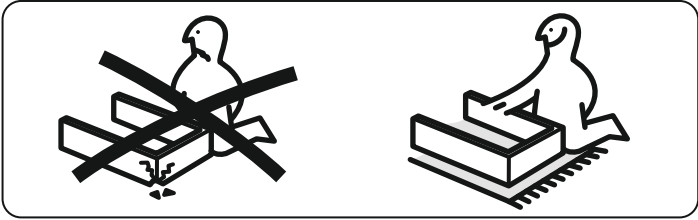
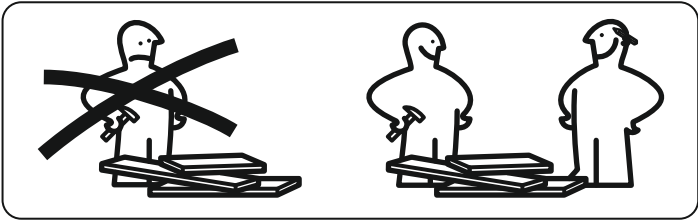

1

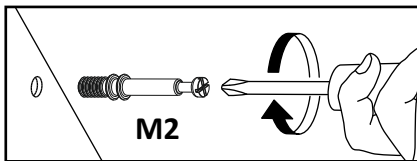
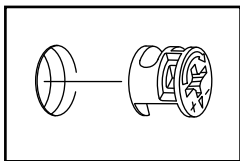
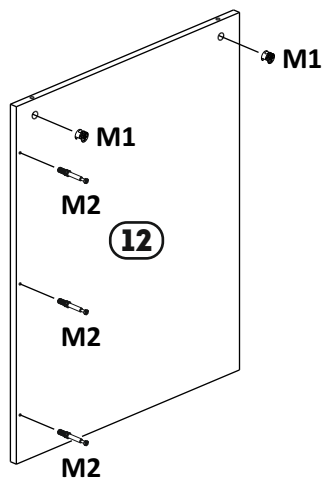
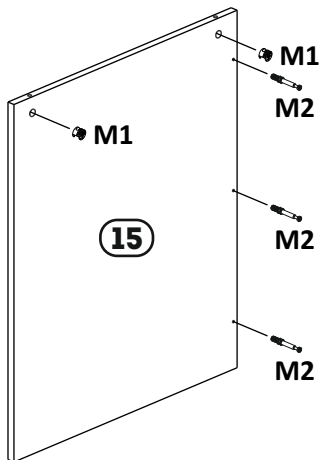
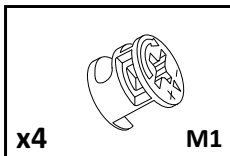
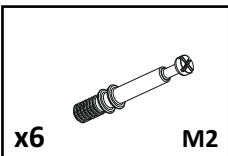

2

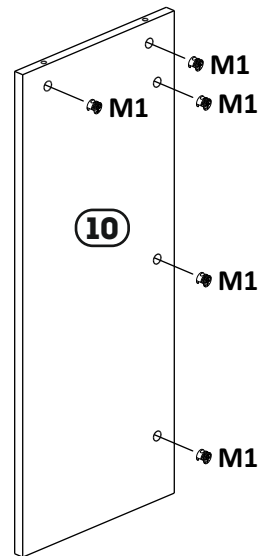
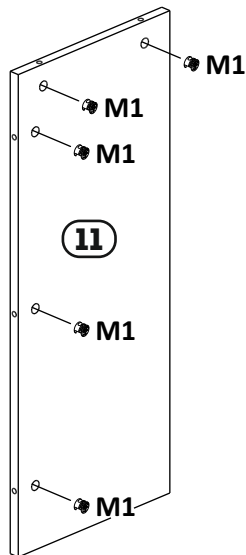
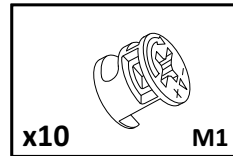

3

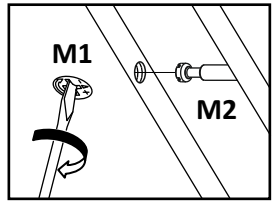
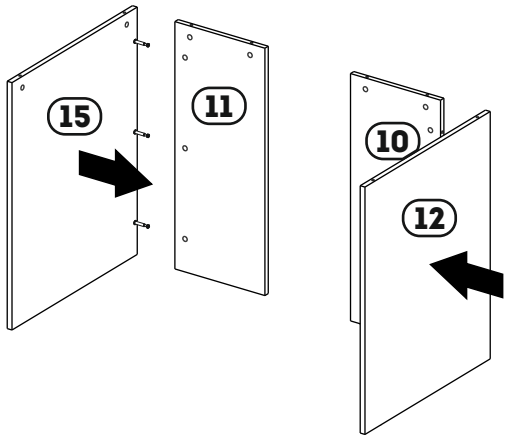

4

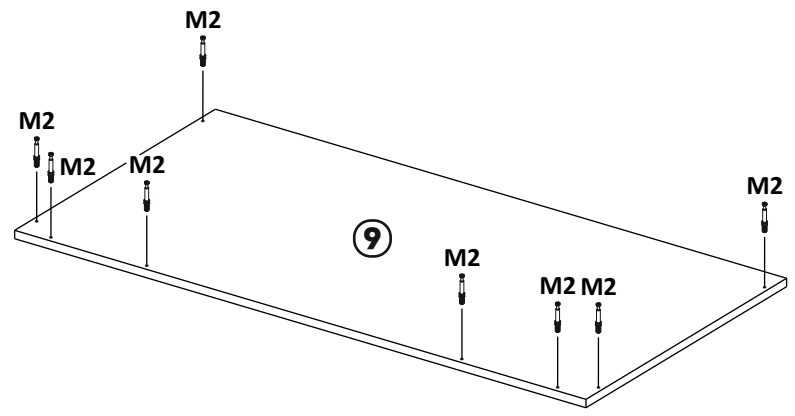
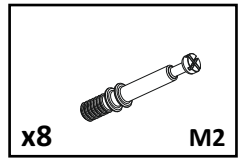

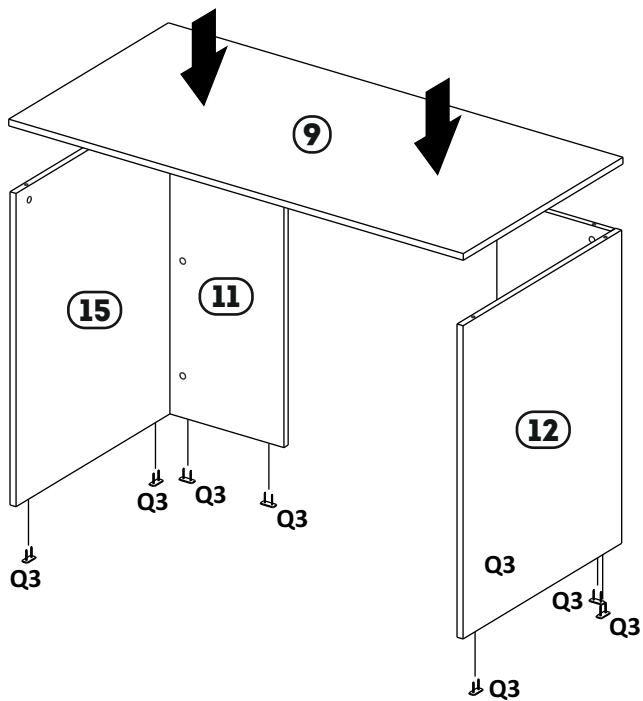
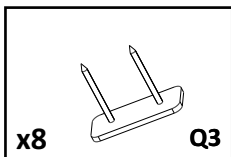
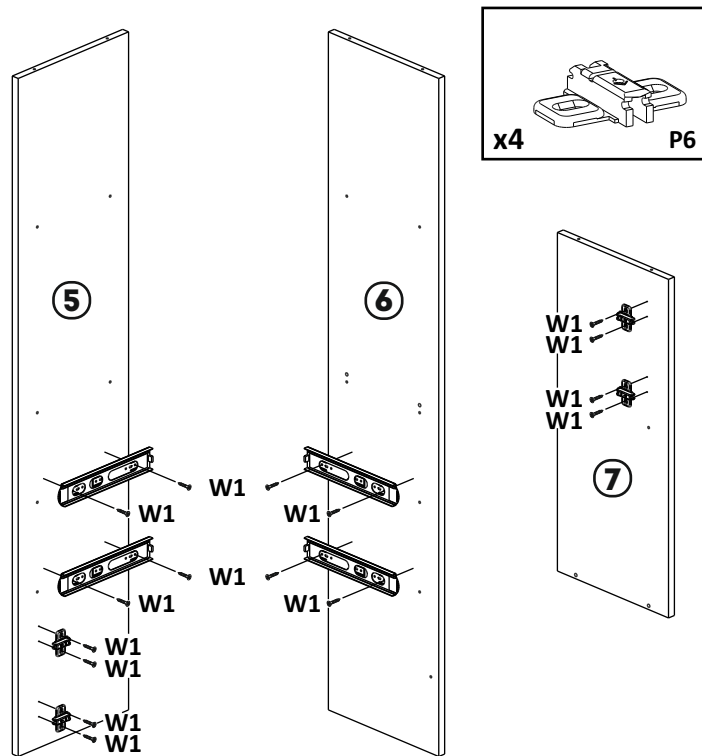
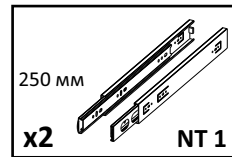
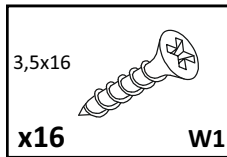
5**6****7**

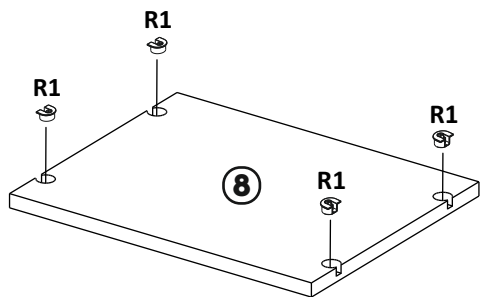
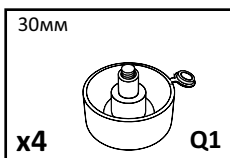
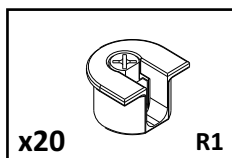
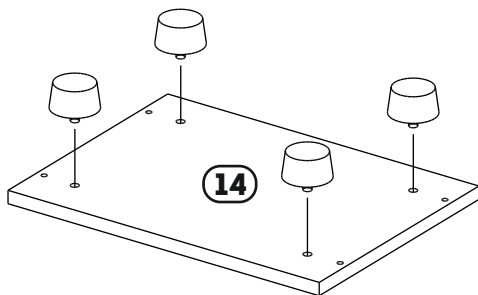
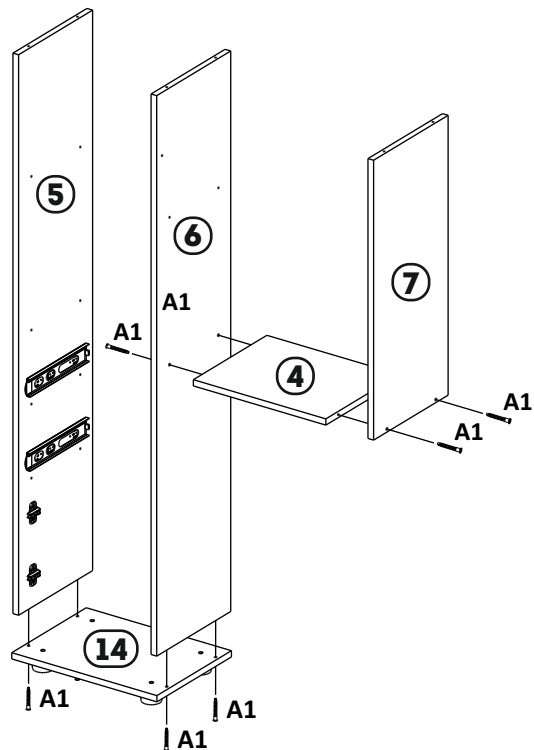
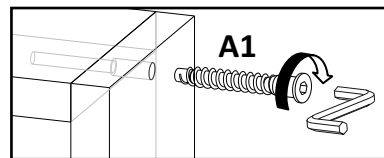
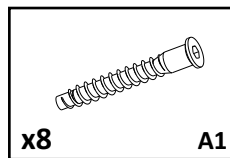
7**x5****8**

9

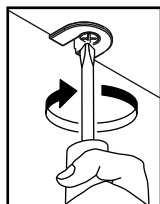
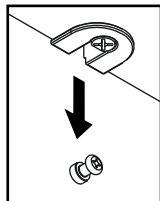
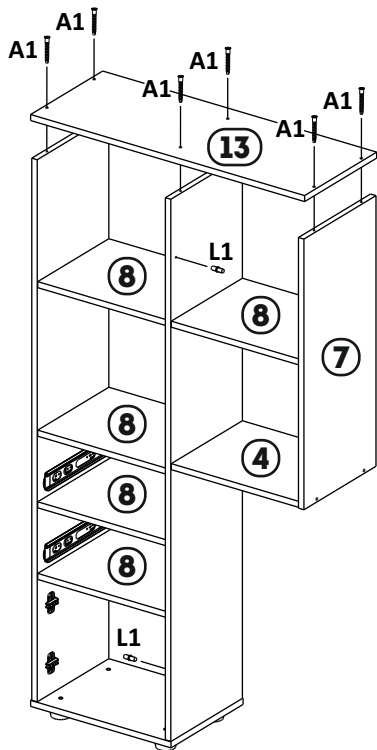
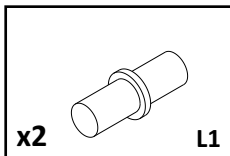
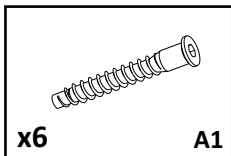

10

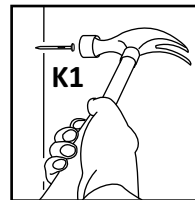
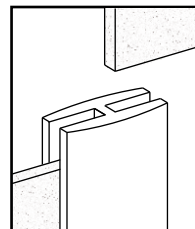
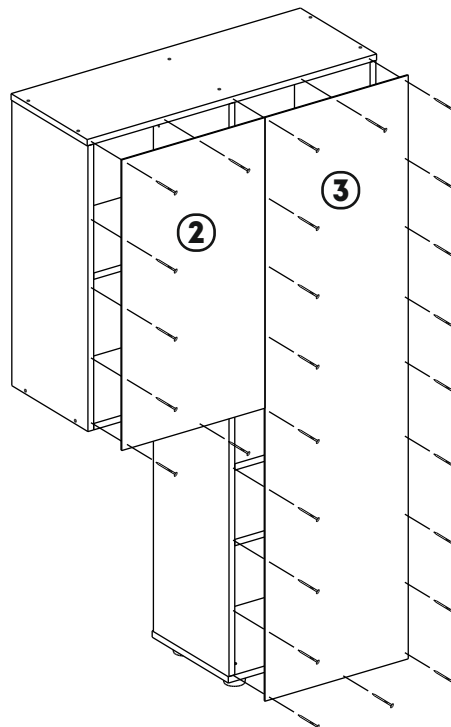
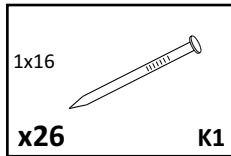

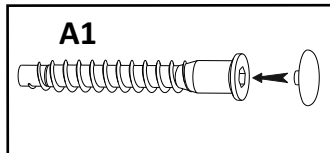
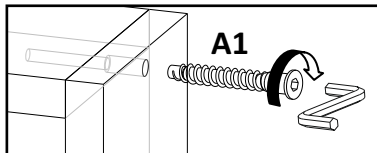
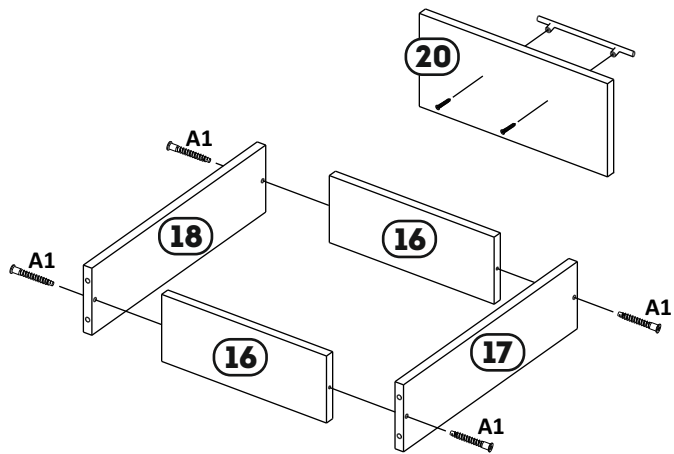
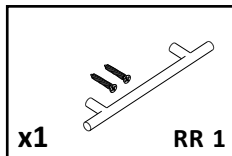
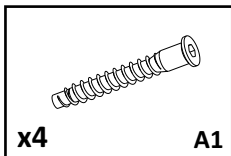
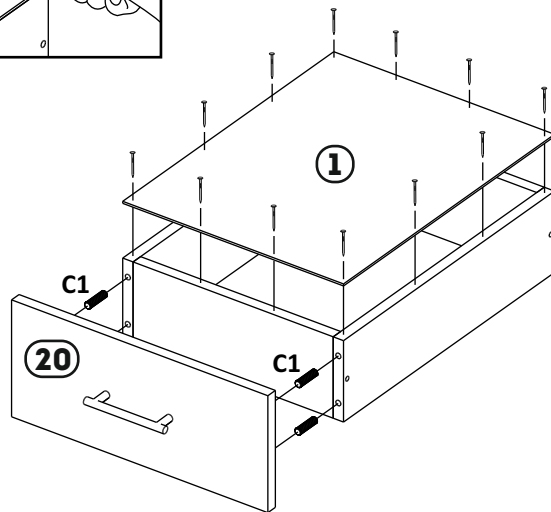
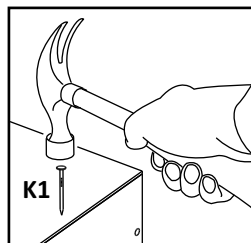
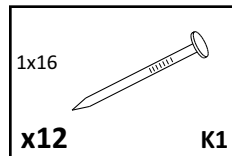
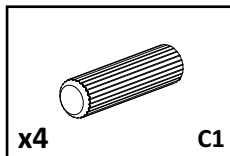
11**12**

13

3,5x16

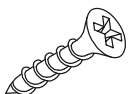

x4

W1

250 mm

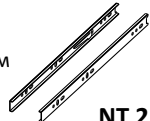

x1

NT 2

3,5x30

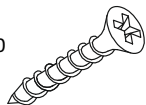

x4

W3

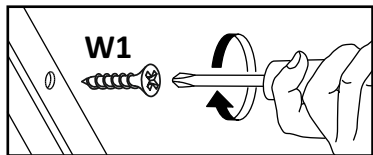
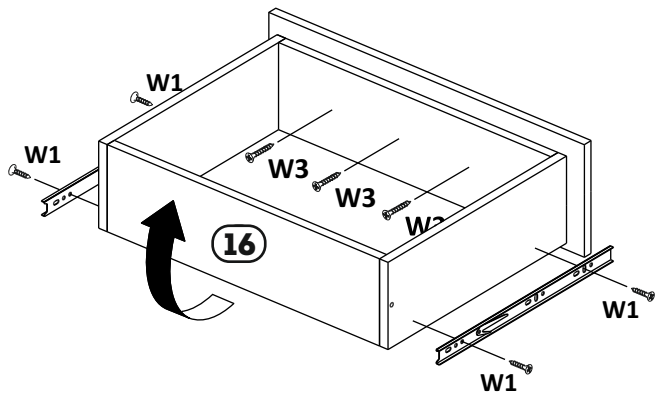

14

x2

RR 1

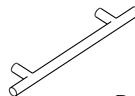

x4

P8

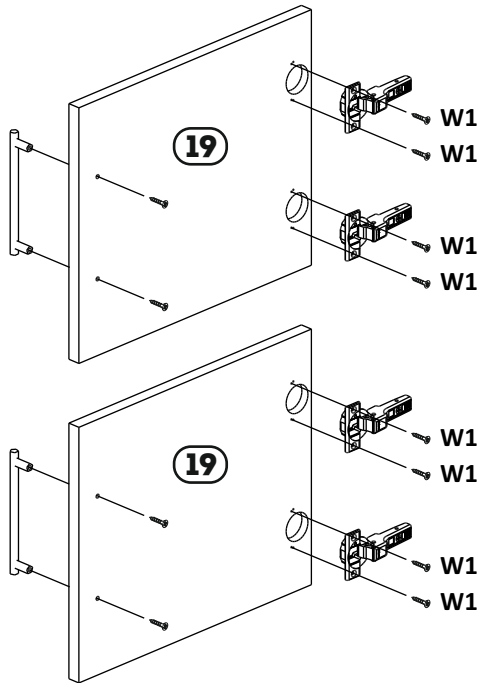
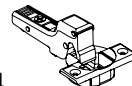

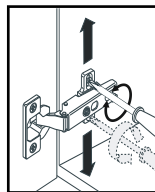
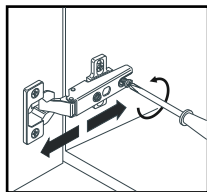
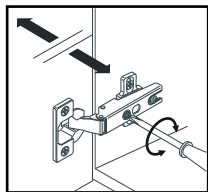
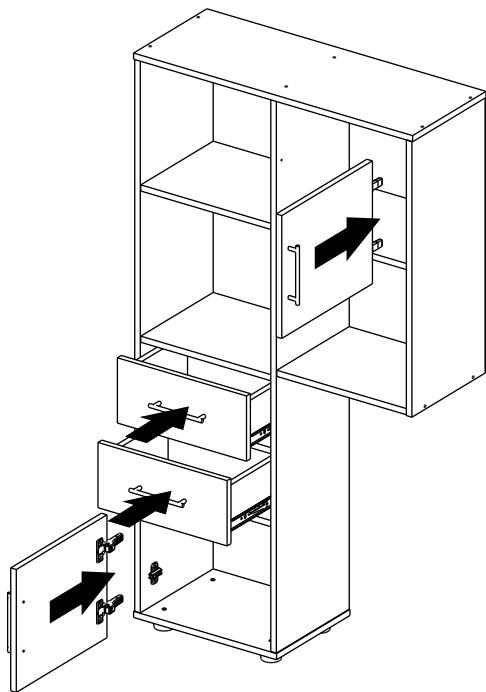
15**16**