







2 X		10min	
			



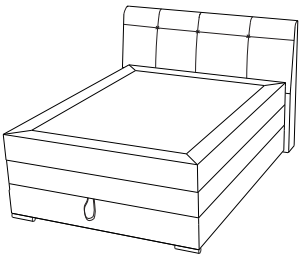
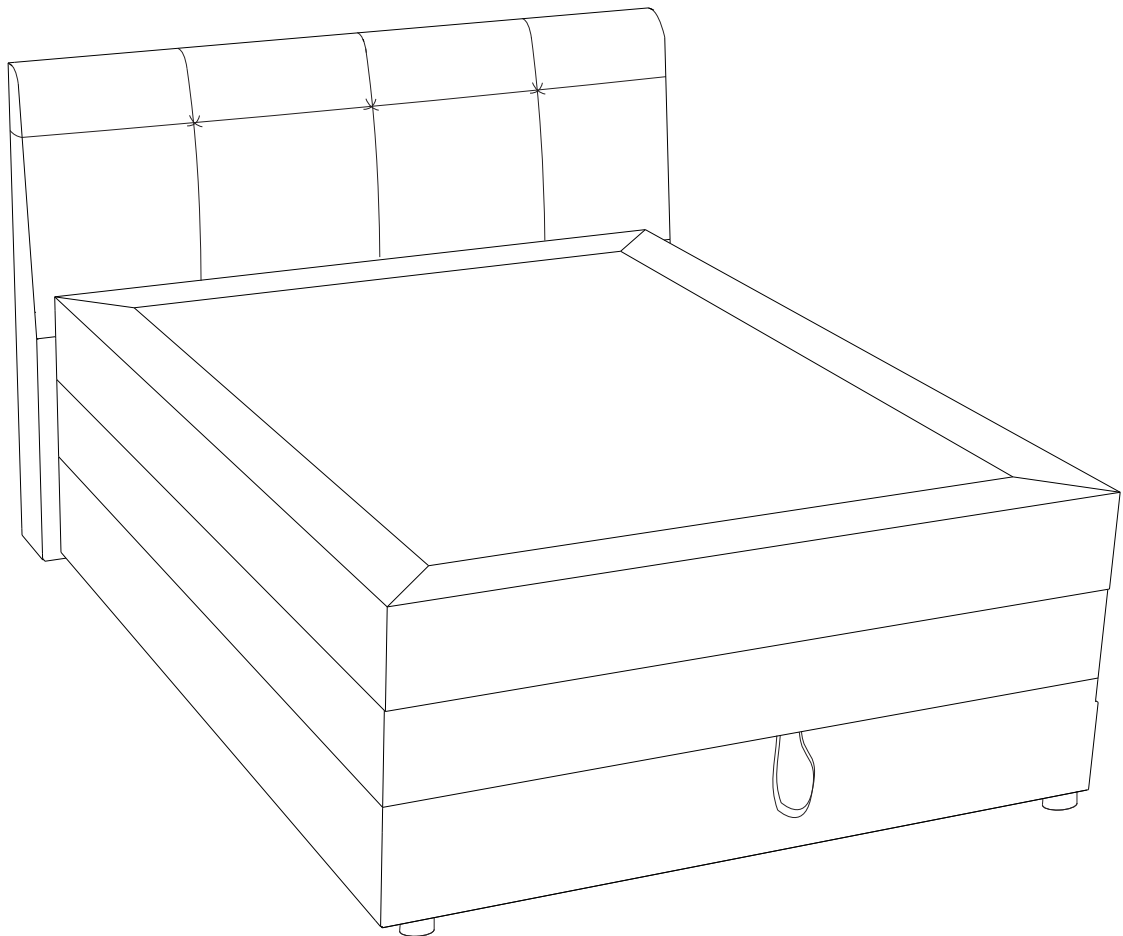
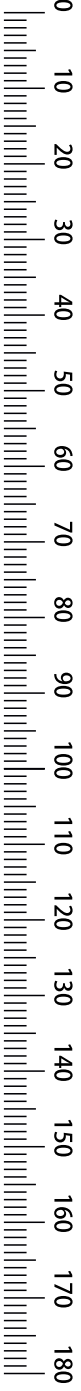

A	 x3	B	 x3	C	 x3
	M8				M8X80

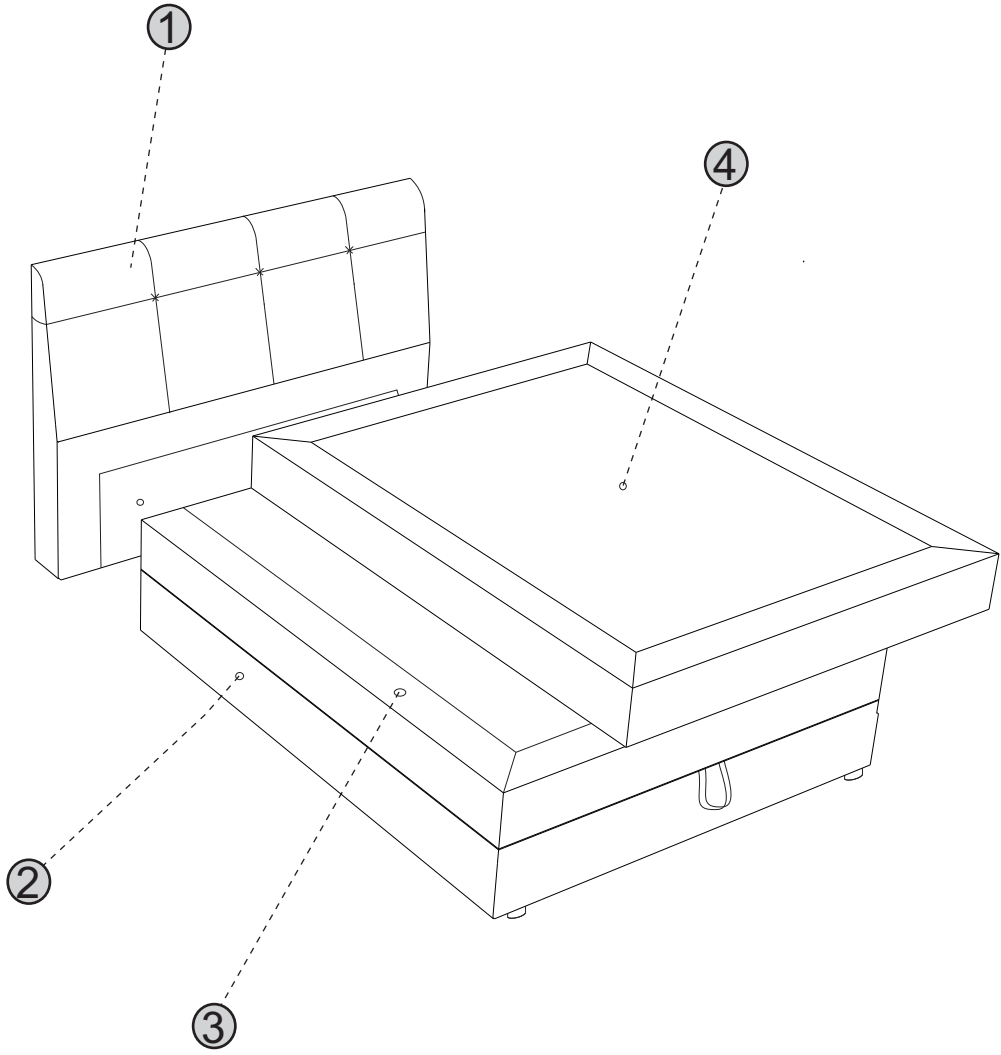
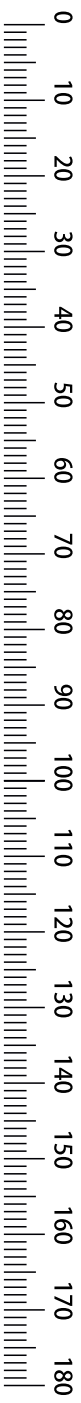
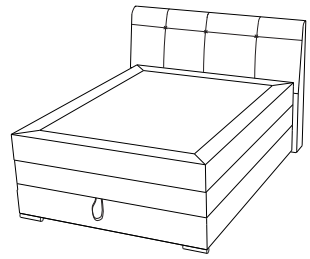

2 X		10min	
			



2 X		10min	⊕
			

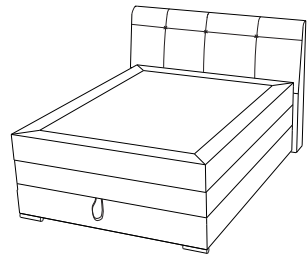

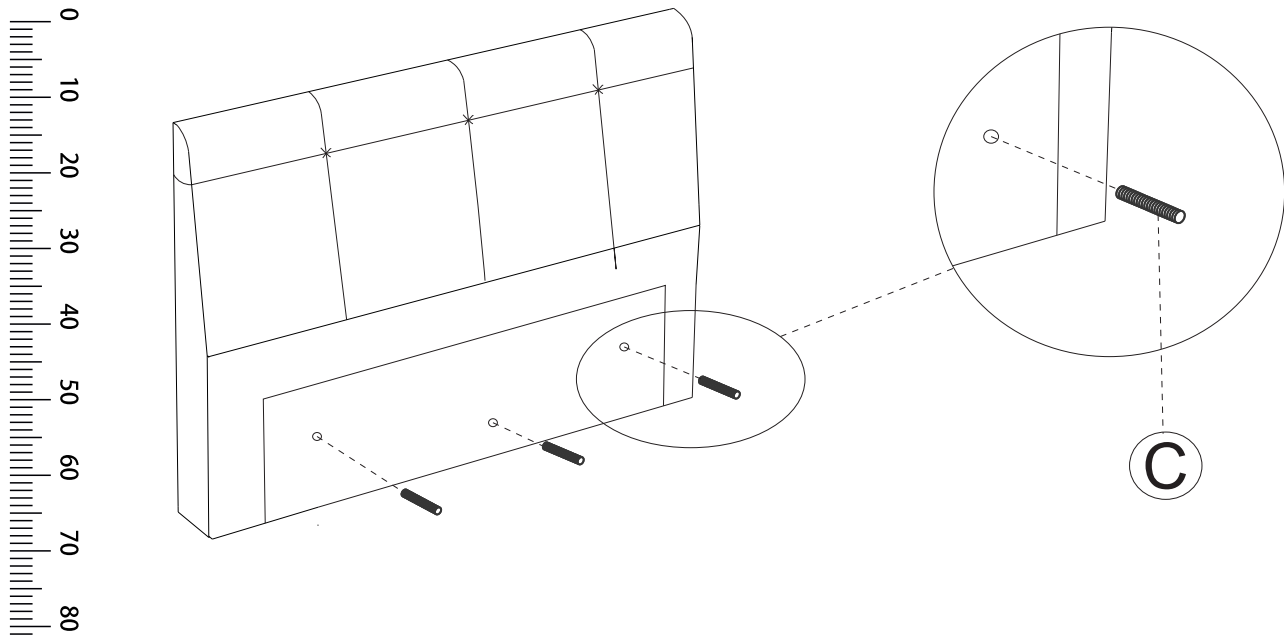

1

C  x3
M8X80





2

A  x3
M8

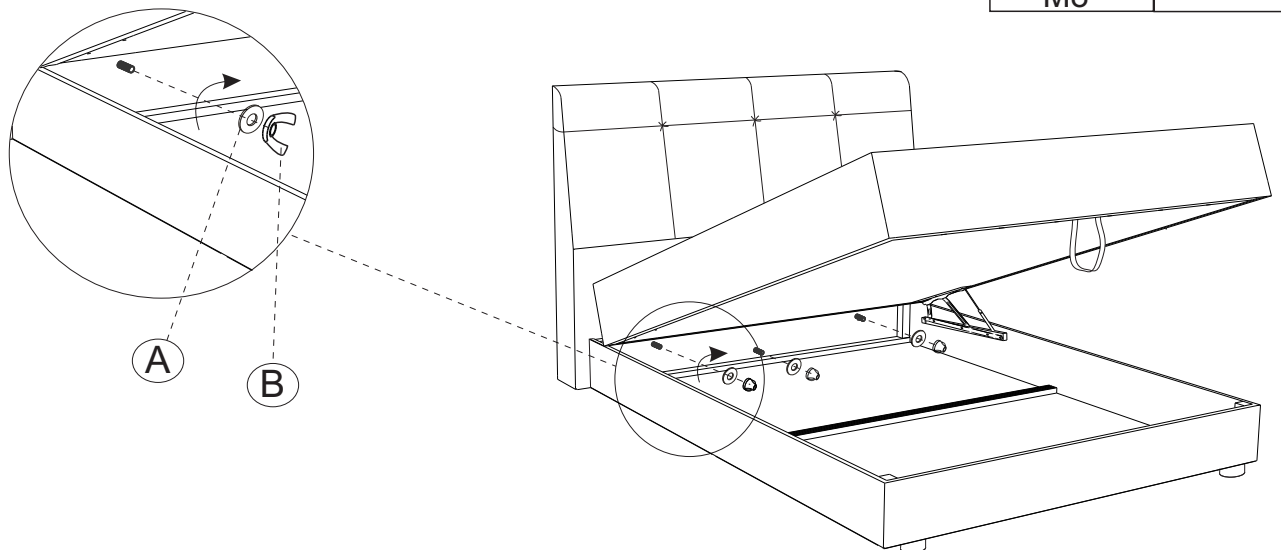
B  x3



2 X		10min	
			

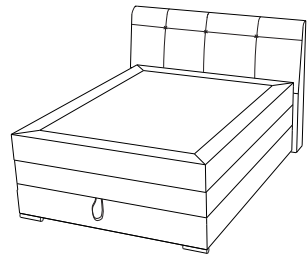

0
10
20
30
40
50
60
70
80
90
100
110
120
130
140
150
160
170
180

