

**Service • Assistenza • Dienstverlening • Serwis
Servis • Szerviz • Servicio • Usluga • Сервисная Служба**

Name • Nom • Nome • Naam • Nazwa
Jméno • Název • Név • Denimire
Nombre • Ime • Isim • Название

SELENE

shop • geschäft • boutique • sklep • winkel • магазин
negozio • bott • tienda • obchod • dućan • madaza • magazin

Nr. • No. • N° • Номер • Č • Sz • Ne

13

Typ • Type • Tip • Típus • Тіро • Тип

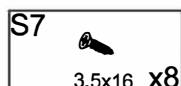
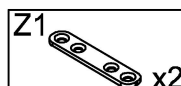
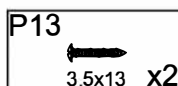
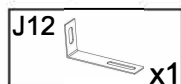
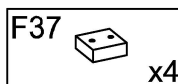
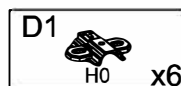
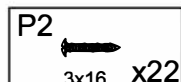
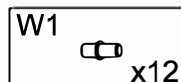
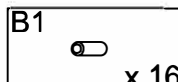
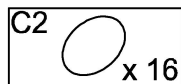
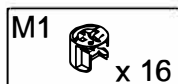
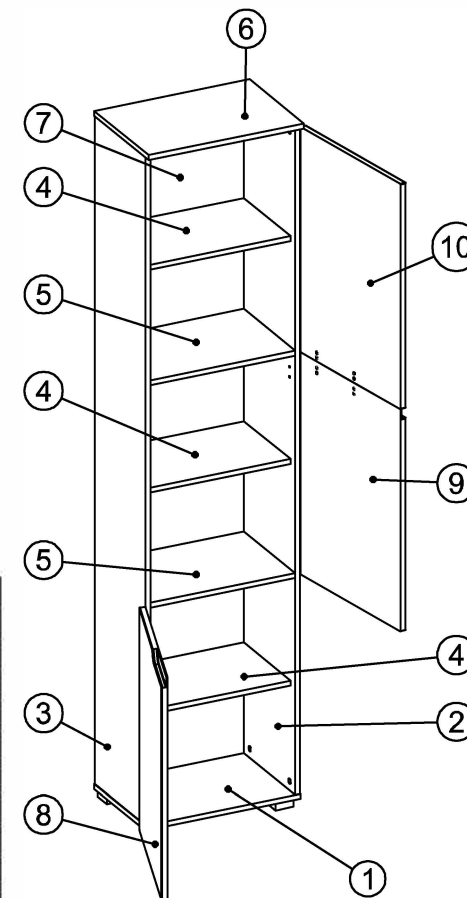
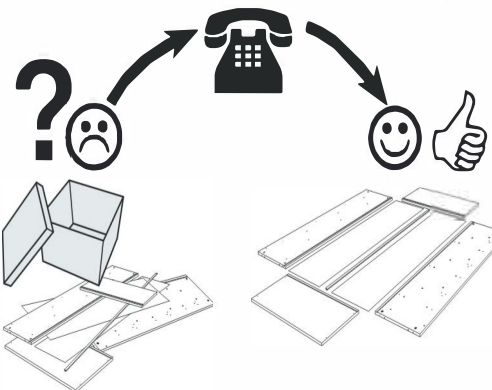
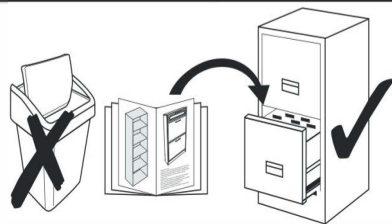

10	711	496	18	1	1
9	703	496	18	1	1
8	703	496	18	1	1
7	2136	494	3	1	1
6	500	350	16	1	1
5	466	328	16	2	1
4	300	466	16	3	1
3	2108	329	16	1	1
2	2108	329	16	1	1
1	500	329,5	16	1	1
Nr	Wymiar		Szt	Paczka	

0 1 2 3 4 5 6 7 8 9 10 11 12 13 14 15 16 17 18 19 20



