

# K7-7 (400)

No	a*b	X
1	720x300	1
2	720x300	1
3	368x290	1
4	398x300	2
5	716x364	1
6	696x396	1

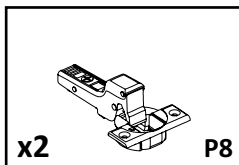

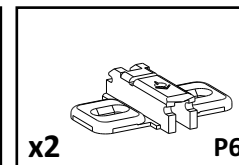
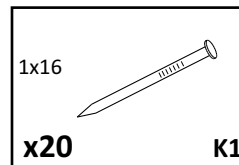
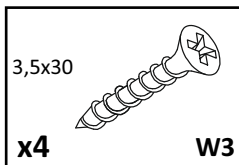
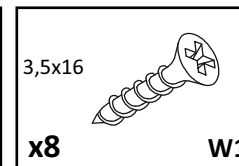
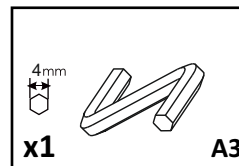
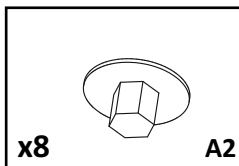
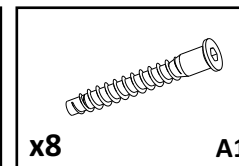
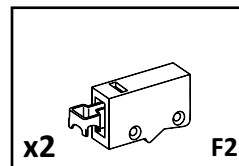
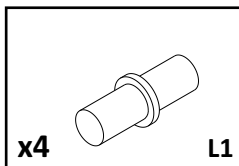
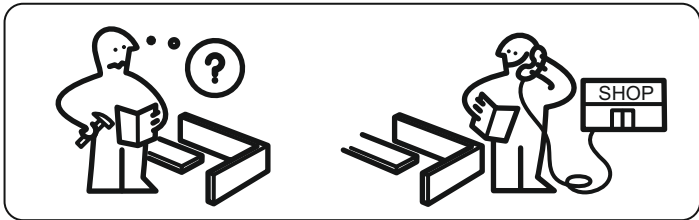
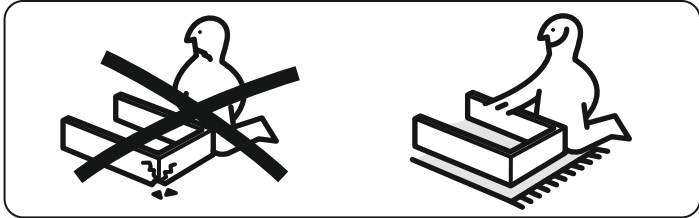
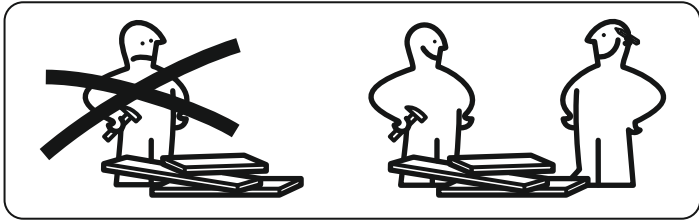
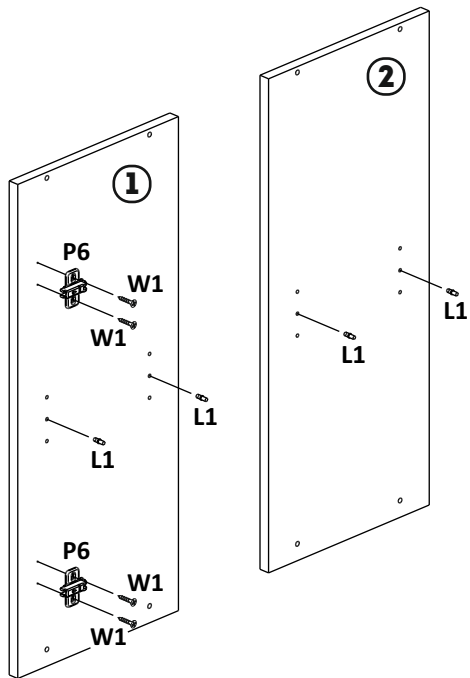
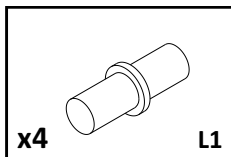
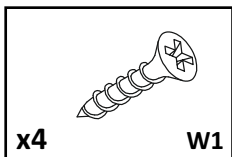
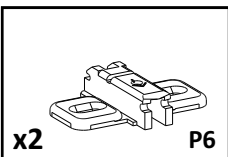
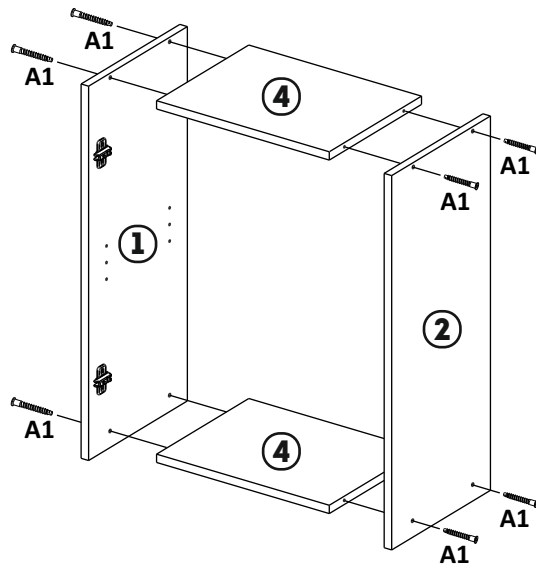
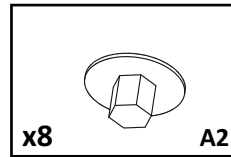
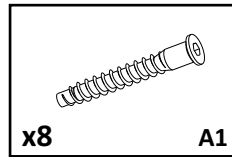

**1****2**

**3**

3,5x30

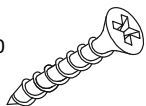

x4

W3

x2

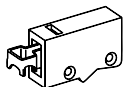

F2

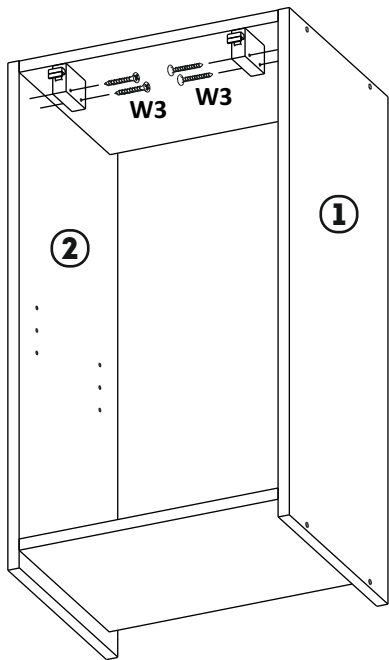

**4**

1x16

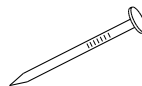

x20

K1

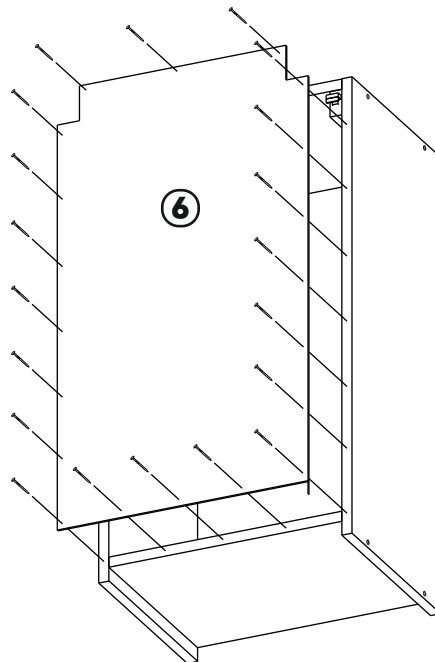
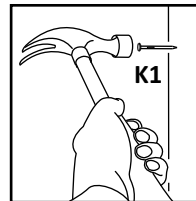

5

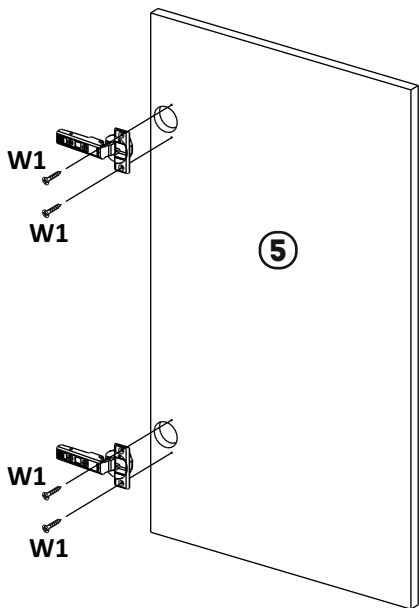
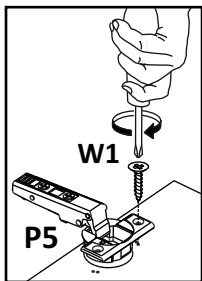
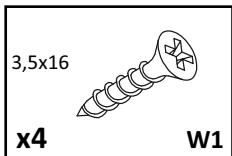
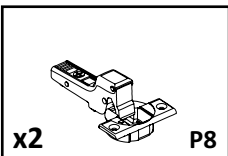

6

